



# ULTRA HD IP

Just Add  Power

 **Just Add Drivers**

 	<b>Just Add Power</b>	<b>Just Add Drivers</b>
 	<b>Configure Switch and Devices</b>	Configure your switch and JAP devices based on answers to a few simple questions about your system configuration
 	<b>Firmware Update Only</b>	Just update the firmware on any JAP devices visible on your LAN
 	<b>Test (Cisco / Luxul)</b>	Manually test the switch configuration
		

# JADCONFIG INSTRUCTIONS

**Revised v3.4.33.0**  
**2017-04-17**

# Table of Contents

---

Download & Install .....	4
Configure Switch and Devices .....	5
Switch Models.....	5
Luxul AMS-1208P, AMS-2616P, AMS-2624P, XMS-2624P, & XMS-5248P .....	6
Luxul AMS-4424P (Stacked or Unstacked) .....	6
Luxul XMS-7048P (Stacked or Unstacked) .....	6
Cisco SG300 .....	7
Cisco SG500 & SG500X (Stacked or Unstacked).....	7
Computer Physical Connections .....	8
Just Add Power Device Connections .....	9
Quick Start Guide.....	10
JADConfig Report.....	16
Static Route – Enable Layer 3 .....	17
Router with Static Route .....	18
Change Default Gateway.....	19
Firmware Update Only.....	20
Test.....	22
License Key .....	24
Expanding a System .....	25
Troubleshooting.....	26
Unable to Ping Default Gateway .....	26
No Serial Ports were Found .....	27
Stuck at “Checking communication with switch” .....	28
Duplicate IP Address Found.....	29
Device Discovery Errors .....	30
Some Devices Discovered.....	30

# JADConfig Instructions – Just Add Power HD over IP – Page3

---

No Devices Discovered ..... 32

Contact Support..... 33









Change Log ..... 34

## Download & Install

- Newest version of JADConfig and associated drivers are always available at [support.justaddpower.com](http://support.justaddpower.com)
  - Download the setup file under *JADConfig* section
  - Run Setup.exe to install JADConfig
  - **Windows ONLY** program
    - Apple hardware running Windows OS may experience issues. Please use a native Windows PC.
  - See the *Control System Drivers* to download control drivers



Just Add Power Just Add Drivers

 	<b>Configure Switch and Devices</b>	Configure your switch and JAP devices based on answers to a few simple questions about your system configuration
 	<b>Firmware Update Only</b>	Just update the firmware on any JAP devices visible on your LAN
 	<b>Test (Cisco / Luxul)</b>	Manually test the switch configuration
 		
		

# Configure Switch and Devices

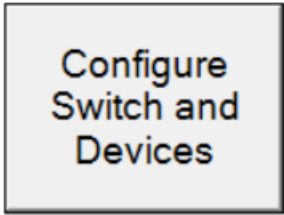

Configure your switch and JAP devices based on answers to a few simple questions about your system configuration

## Switch Models

Click switch model for additional information

Make	Model	Layer 3	Stackable	Max Devices
Luxul	<a href="#">AMS-1208P</a>	✓		7
	<a href="#">AMS-2616P</a>	✓		23
	<a href="#">AMS-2624P</a>	✓		23
	<a href="#">XMS-2624P</a>	✓		23
	<a href="#">XMS-5248P</a>	✓		47
	<a href="#">AMS-4424P</a>	✓	✓	368
	<a href="#">XMS-7048P</a>	✓	✓	752
Cisco	<a href="#">SG300</a>	✓		51
	<a href="#">SG500 &amp; SG500X</a>	✓	✓	376

## Luxul AMS-1208P, AMS-2616P, AMS-2624P, XMS-2624P, & XMS-5248P

- All of these models provide the same performance but have different numbers of ports. The AMS-1208P, AMS-2616P, and AMS-2624P have port connections on the back, while the XMS-2624P and XMS-5248P have ports on the front.
- These models are all standalone; they do **NOT** support stacking. Use the AMS-4424P or XMS-7048P for stacking
- Each Just Add Power PoE device uses **10 Watts** of power.

Switch Model	Just Add Power Ports	PoE devices	Wattage
AMS-1208P	7	7	130W
AMS-2616P	23	16 (ports 9-24)	250W
AMS-2624P	23	23	370W
XMS-2624P	23	23	370W
XMS-5248P	47	47	740W

## Luxul AMS-4424P (Stacked or Unstacked)

- The AMS-4424P supports up to sixteen (16) stacked units for a maximum of 368 Just Add Power devices
  - Currently, the AMS-4424P and XMS-7048P cannot be part of the same stack
- Each Just Add Power PoE device uses **10 Watts** of power.

Switch Model	Just Add Power Ports	PoE devices	Wattage
AMS-4424P	23	23	250W

## Luxul XMS-7048P (Stacked or Unstacked)

- The XMS-7048P supports up to sixteen (16) stacked units for a maximum of 752 Just Add Power devices
  - Currently, the AMS-4424P and XMS-7048P cannot be part of the same stack
- Each Just Add Power PoE device uses **10 Watts** of power.

Switch Model	Just Add Power Ports	PoE devices	Wattage
XMS-7048P	47	47	740

## Cisco SG300

- The Cisco SG300 has multiple models with different PoE capability and device capacity.
- This model is standalone; it does **not** support stacking. Use the Cisco SG500 for stacking.
- Each Just Add Power PoE device uses **10 Watts** of power.

Switch Model	Just Add Power Ports	PoE devices	Wattage Available	
			P model	MP model
SG300-10	9	7	62W	124W
SG300-20	19	0		
SG300-28	27	23	180W	375W
SG300-52	51	47	375W	740W

## Cisco SG500 & SG500X (Stacked or Unstacked)

- The Cisco SG500 has multiple models with different PoE capability and device capacity. Up to eight (8) SG500/SG500X units can be stacked together for a maximum of 376 Just Add Power devices.
- Each Just Add Power PoE device uses **10 Watts** of power.

Switch Model	Just Add Power Ports	PoE devices	Wattage Available	
			P model	MP model
SG500-28	25	23	180W	740W
SG500-52	49	47	375W	740W
SG500X-24	23	23	375W	740W
SG500X-48	47	47	375W	740W

## Computer Physical Connections

JADConfig relies on 2 types of physical connections in order to configure a Just Add Power HDMI over IP system:

1. Network connection
2. Serial connection

These connections must be made, regardless of the switch model being used.

### Network Connection

A network connection is used for device discovery when setting up a Just Add Power system. The following network connections must be made.

1. Local Area Network connected to **port 1** of the Managed network switch.
2. Computer running JADConfig connected to the same Local Area Network. This connection can be wired or wireless as long as port 1 has the **ONLY** network connection to the Managed network switch. This means that port 1 is the **ONLY** port with non-Just Add Power devices connected to it.
3. Router (or other DHCP-provider) connected to the Local Area Network to provide an initial IP address to the computer and switch so they can communicate.

### Serial Connection

A serial connection from a computer running JADConfig to the Managed network switch is used to initially configure the number of inputs and outputs of the switch. If the computer does not have a native DB9 port, then a USB-to-Serial adapter will be needed.



USB-to-Serial Adapter

### Example

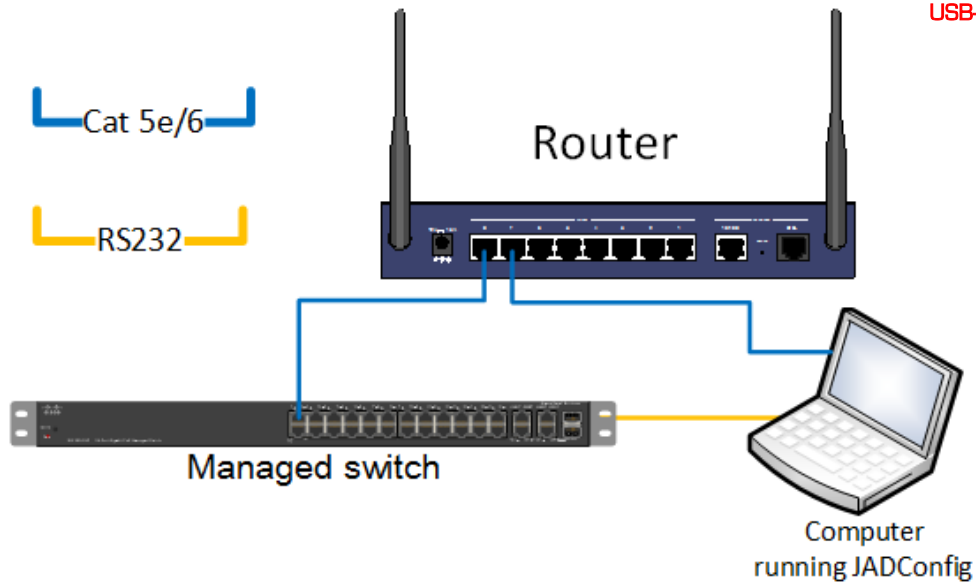



## Just Add Power Device Connections

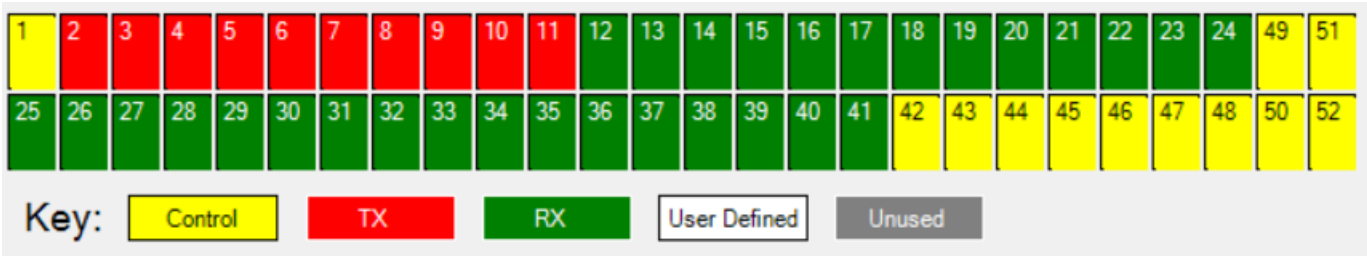

Connections for Just Add Power devices follow a template where  $n$  is the number of Transmitters and  $m$  is the number of Receivers:

- Port 1 - Control port
- Port 2 to port  $n + 1$  - Transmitter ports in order starting at port 2
- Port  $n + 2$  to  $n + m + 1$  - Receiver ports in order starting after the last Transmitter
- Remaining ports - Control or user-defined ports starting after the last Receiver

Port 1 of the managed switch **MUST** be connected to the LAN when running JADConfig.

Additional Transmitter or Receiver ports can be configured even if there is no Just Add Power device to add to that port. Those ports will be configured for the appropriate device regardless of whether a Just Add Power device is attached.

### Example

The image above shows a system of 10 Transmitters and 30 Receivers. Transmitter ports are 2-11, and Receiver ports are 12-41. When JADConfig is run, there are only 8 Transmitters and 27 Receivers connected.

- Ports 10-11 do not have Transmitters attached, but will still be configured as Transmitter ports.
- Ports 39-41 do not have Receivers attached, but will still be configured as Receiver ports.
- Devices can be attached to these ports at a later time. See Expanding a System.

### Example

To add a 2G+4+ Tiling Transmitter to a system, treat the 2G+4+ as 4 Receivers and 1 Transmitter when counting the number of devices.

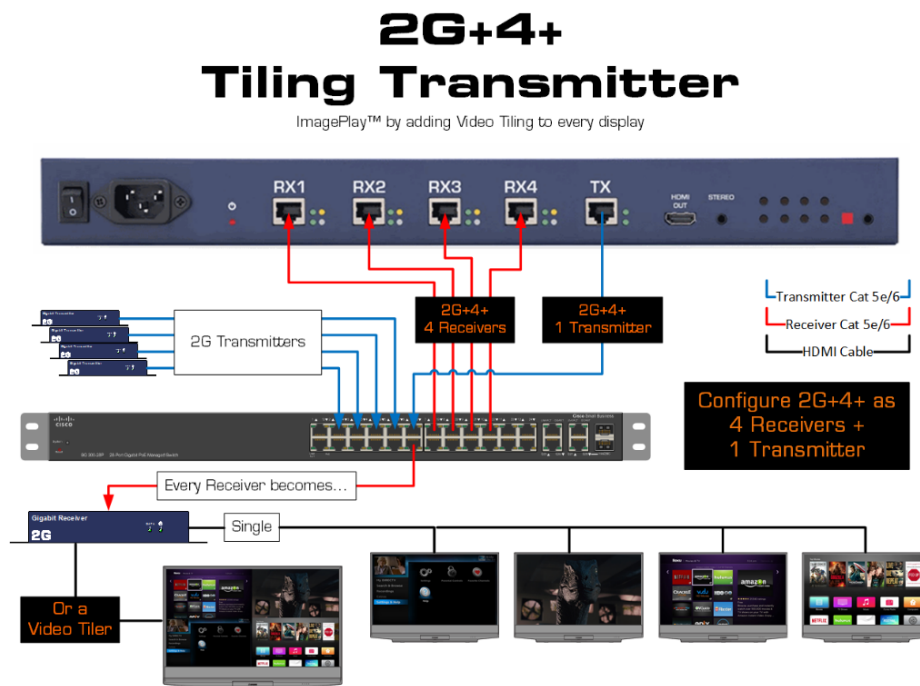

## Quick Start Guide

1. Connect the computer and switch to the network as described in [Physical Connections](#).
2. Disconnect all HDMI cables from Transmitters. This ensures that no video traffic is passing through the system during configuration.
  - a. If the installation has a **2G+4+ Tiling Transmitter**, press and hold the PF1 button until the Data light next to the TX is flashing. This disables HDMI output for the 2G+4+.
3. Select the network interface, COM port, and Switch Family. The default username and password will autofill. Click **Next>**

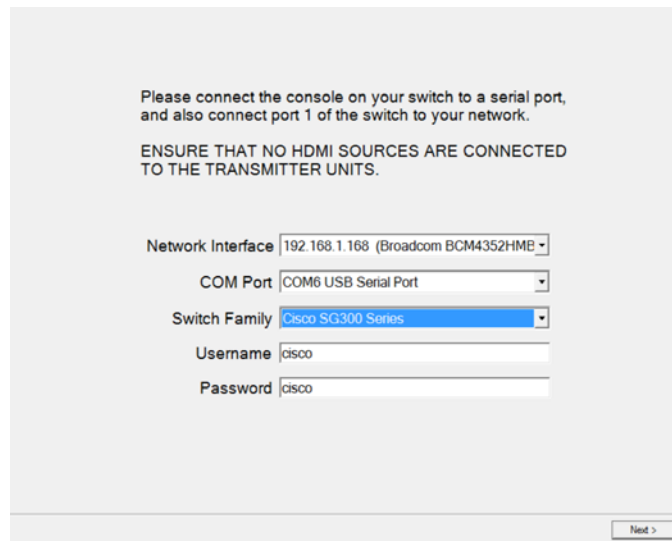

Please connect the console on your switch to a serial port, and also connect port 1 of the switch to your network.

ENSURE THAT NO HDMI SOURCES ARE CONNECTED TO THE TRANSMITTER UNITS.

Network Interface: 192.168.1.168 (Broadcom BCM4352HME)

COM Port: COM6 USB Serial Port

Switch Family: Cisco SG300 Series

Username: cisco

Password: cisco

Next >

4. The switch will perform initial configuration on the switch and reset it in router mode. This will take a few minutes.

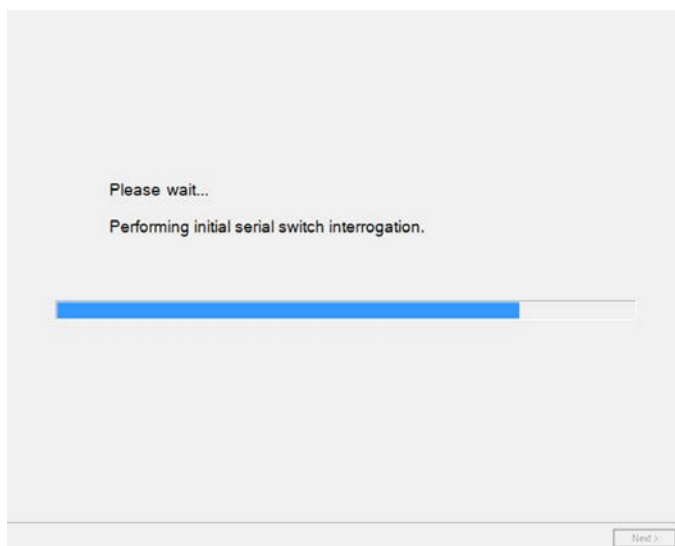

Please wait...

Performing initial serial switch interrogation.

Progress bar: [A blue progress bar is shown, approximately 75% full.]

Next >

**NOTE:** If not using stacked switches, skip to step 7.

5. If using a stackable switch – Cisco SG500 or Luxul AMS4424P – follow the instructions to set the stack configuration for each unit in the stack. The stacking cables between the switches should begin **disconnected**.
6. Once the program says so, connect the stacking cables. Allow 4-5 minutes for the stack to negotiate, then click Configure Stack or Verify Stack.

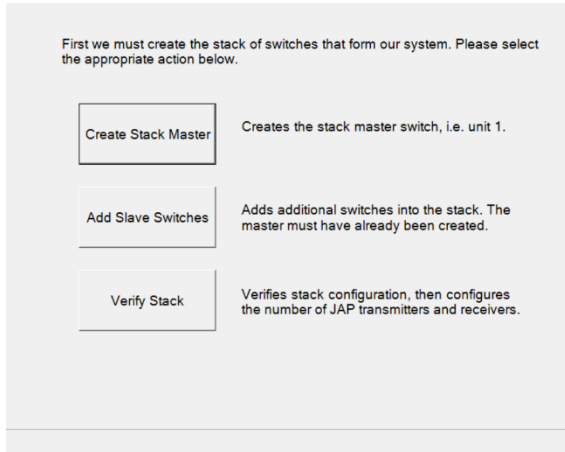

Cisco SG500

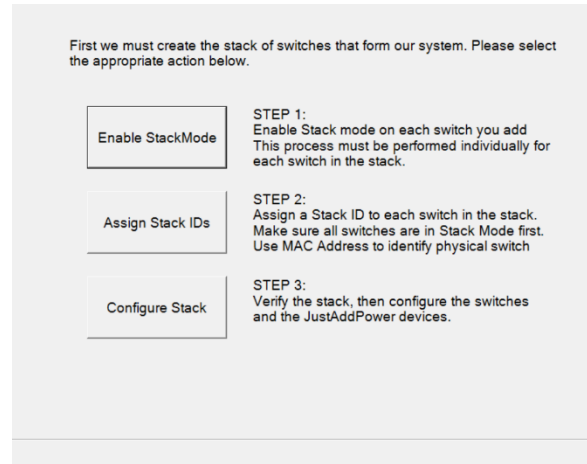

Luxul AMS4424P

# JADConfig Instructions – Just Add Power HD over IP – Page12

7. Fill in the information for the size of the system and click **Next>**

<b>Transmitter Ports</b>	The number of Transmitters in the system. Stacked: the number of Transmitters on each stack unit Additional Transmitter ports can be programmed for future expansion <b>(Note: Each Plus-Four-Plus uses <u>one</u> Transmitter port)</b>
<b>Receiver Ports</b>	The number of Receivers in the system. More Receivers can be programmed than are actually present. Stacked: the number of Receivers on each stack unit Additional Receiver ports can be programmed for future expansion <b>(Note: Each Plus-Four-Plus uses <u>four</u> Receiver ports)</b>
<b>Default Transmitter</b>	The Transmitter that will be shown on all screens by default
<b>Unused Port Mode</b>	Control VLAN: unused ports will be placed on the Control VLAN (port 1 is Control VLAN) User Defined: unused ports will be unconfigured
<b>Switch IP Address</b>	IP Address for the switch. Must be on the local network, outside the DHCP range, and unique to this switch
<b>Default Route</b>	The IP of the router on the Local network
<b>InterVLAN Routing</b>	Enabled always
<b>JAP LAN</b>	IP scheme to be assigned to the Just Add Power devices. Must be outside the local network IP and unique to the Just Add Power devices.
<b>Advanced</b>	Check the box to customize the JAP LAN, Default Route, and Unused Port Mode

Please enter the following information about your system configuration.  
ENSURE THE SWITCH ADDRESS SPECIFIED IS NOT ALREADY ASSIGNED TO ANOTHER DEVICE.

Stack Unit 1 2 3 4 5 6 7 8

Trunk Bandwidth Estimation  
Sufficient capacity for 100Mbps content

Transmitter Ports 11 11 0 0 0 0 0 0

Receiver Ports 12 12 0 0 0 0 0 0

Default Transmitter 1

Unused port mode Control VLAN

Switch IP Address 192.168.0.99

Default Route 192.168.0.1

Advanced

InterVLAN Routing Enabled

Just Add Power LAN Class A (10.xxx)

Next >

**Stacked switch**

Please enter the following information about your system configuration.  
ENSURE THE SWITCH ADDRESS SPECIFIED IS NOT ALREADY ASSIGNED TO ANOTHER DEVICE.

Transmitter Ports 10

Receiver Ports 30

Default Transmitter 7

Unused port mode Control VLAN

Switch IP Address 192.168.1.254

Default Route 192.168.1.1

Advanced

InterVLAN Routing Enabled

JAP LAN Class A (10.xxx)

Next >

**Standalone switch**

8. Confirm system information at the following window and click **Next>**

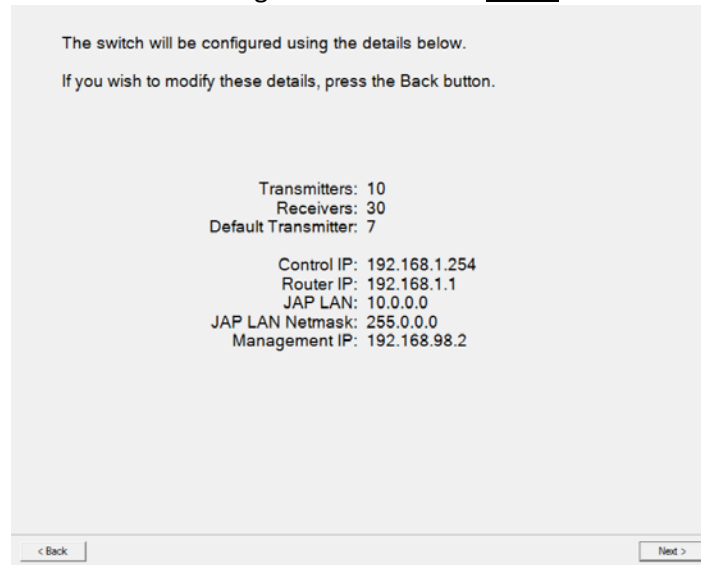

9. Once the switch is configured, connect Transmitters and Receivers to the switch as shown in the diagram and click **Next>**.

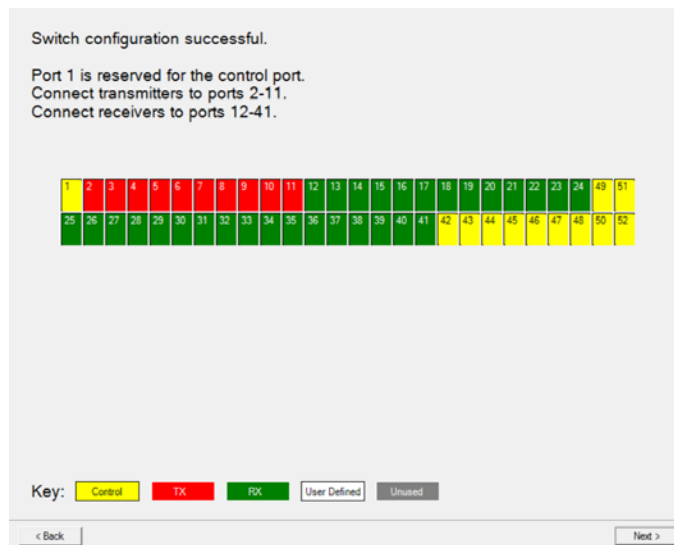

10. Confirm that all HDMI cables are disconnected from Transmitters, check the box on the popup window, and click **OK**.



11. The discovery process will go out and find all Just Add Power devices on the network. If not all devices are discovered, see [Troubleshooting – Device Discovery Errors](#). If a complete rescan is necessary – for example if devices were connected to the wrong ports or needed to be reconnected for other reasons – click **Clear and Rescan**. If only a partial rescan is needed – for example a couple devices were missed but no devices were moved – click **Rescan and Append**. If all devices were discovered, click **Next>** to move forward.
  - a. If 2G devices are being installed alongside 2GΩ/3G or 3G devices in the same system, select 2G from the dropdown box at the bottom. This will put the 2GΩ/3G devices and 3G devices into 2G Mode so they are compatible with 2G devices.

**DO NOT** select “Force configuration of already configured devices” unless advised by Technical Support.

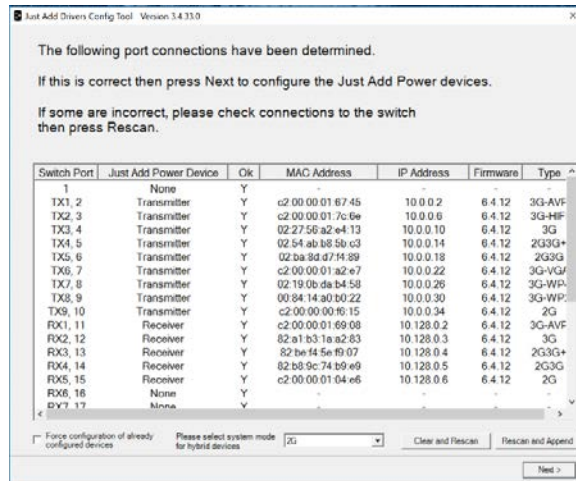

12. Choose a firmware version to load onto the devices. Just Add Power recommends using the latest firmware version
  - a. Latest firmware for 3G is **A6.4.12**
  - b. Latest firmware for 2G is **A6.4.12**

**DO NOT** select “Force firmware reload even if already on chosen version” unless advised by Technical Support.

13. Select **Choose Image** to load an Image Push – background image – on each Receiver to show when there is no video content.
  - a. A .jpg image with 24-bit color depth must be used
  - b. Any resolution image can be used, but will be displayed in 640 x 480

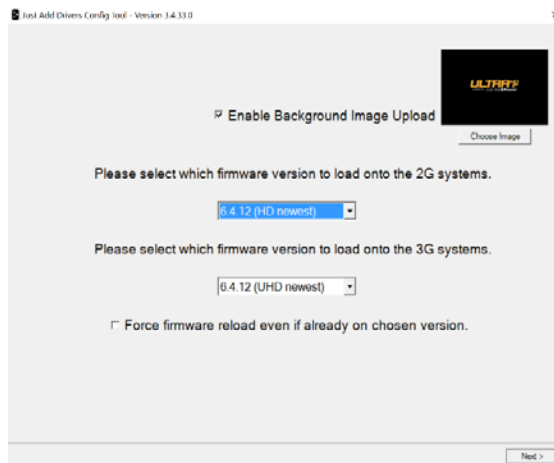

14. Finished! Click **Export** to download a text document with system details, and **Finish** to close the software.
  - a. If there is a 2G+4+ in the system, use the power switch on the 2G+4+ to power cycle it to restore HDMI output.

System configuration is complete.

Note that the following static route must be added to your router so that the control system can access the Just Add Power devices:

Network: 10.0.0.0 Netmask: 255.0.0.0 Gateway: 192.168.0.99

The Just Add Power devices should be configured using the details shown below.

Uni...	Just Add Power Device	Firmware	IP Address	Netmask	Gateway	Type
1 / 1	None (Control port)	-	-	-	-	??
1 / 2	TX1 c2:00:00:01:99:47	A5.3.1 FC+4+	10.0.0.2	255.0.0.0	10.0.0.1	2G
1 / 3	TX2 c2:00:00:00:6b:74	A5.3.1 FC+4+	10.0.0.6	255.0.0.0	10.0.0.5	2G
1 / 4	TX3 c2:00:00:00:f6:4b	A5.3.1 FC+4+	10.0.0.10	255.0.0.0	10.0.0.9	2G
1 / 5	TX4 not present	-	10.0.0.14	255.0.0.0	10.0.0.13	??
1 / 6	TX5 not present	-	10.0.0.18	255.0.0.0	10.0.0.17	??
1 / 7	TX6 not present	-	10.0.0.22	255.0.0.0	10.0.0.21	??
1 / 8	TX7 not present	-	10.0.0.26	255.0.0.0	10.0.0.25	??
1 / 9	TX8 not present	-	10.0.0.30	255.0.0.0	10.0.0.29	??
1 / 10	TX9 not present	-	10.0.0.34	255.0.0.0	10.0.0.33	??
1 / 11	TX10 not present	-	10.0.0.38	255.0.0.0	10.0.0.37	??
1 / 12	TX11 not present	-	10.0.0.42	255.0.0.0	10.0.0.41	??
2 / 2	TX12 c2:00:00:01:7c:42	A6.1.10 JAP	10.0.0.46	255.0.0.0	10.0.0.45	3G-HIFI
2 / 3	TX13 c2:00:00:01:4c:ed	A6.1.10 JAP	10.0.0.50	255.0.0.0	10.0.0.49	3G
2 / 4	TX14 not present	-	10.0.0.54	255.0.0.0	10.0.0.53	??
2 / 5	TX15 not present	-	10.0.0.58	255.0.0.0	10.0.0.57	??
2 / 6	TX16 not present	-	10.0.0.62	255.0.0.0	10.0.0.61	??
2 / 7	TX17 not present	-	10.0.0.66	255.0.0.0	10.0.0.65	??

## JADConfig Report

JADConfig creates a Report every time the program successfully completes. The last screen gives the opportunity to Export the JADConfig Report as a .txt file. This Report file should be stored with other documentation for the installation.

Configuration generated at 10:16 on Mon 18 July 2016

Switch family: Luxul AMS7048P (Stacked) Switch Model  
Username: admin Username  
Password: admin Password

Note that the following static route must be added to your router so that the control system can access the Just Add Power devices:

Network: 10.0.0.0    Netmask: 255.0.0.0    Gateway: 192.168.0.99    Static Route information - add to Router for Layer 3 access

Luxul Stack configuration (use MAC Address to identify Stack unit ID (SID)):

SID 1:    a4-13-4e-2b-e8-01 Stack Unit IDs  
SID 2:    a4-13-4e-2c-32-1f

Just Add Power Device Configuration:

Stack & Port	TX/RX #	MAC Address	IP Address	Subnet Mask	Gateway	2G/3G	Firmware
Unit 1, port 2) Transmitter 1	1	[c2:00:00:01:99:47],	10.0.0.2 /	255.0.0.0	(gateway 10.0.0.1)	2G	A5.3.1 FC+4+
Unit 1, port 3) Transmitter 2	2	[c2:00:00:00:6b:74],	10.0.0.6 /	255.0.0.0	(gateway 10.0.0.5)	2G	A5.3.1 FC+4+
Unit 1, port 4) Transmitter 3	3	[c2:00:00:00:f6:4b],	10.0.0.10 /	255.0.0.0	(gateway 10.0.0.9)	2G	A5.3.1 FC+4+

### File Location (based on Windows 8 64-bit)













C:\Program Files (x86)\Just Add Power\JADConfig\Reports

- File is named according to the date and time that JADConfig completed.



## Static Route – Enable Layer 3

A Static Route is needed in order for Layer 3 features of Just Add Power to work.

Feature	Layer 2	Layer 3
Matrix Switching		
RS-232 control of endpoints	 Limited	
CEC control		
Video Wall management		
Logical USB enable/disable		
On-screen Display		
Image Pull – preview video from a source or display		
Image Push – upload a background image		
Gigabit internet access on same CatX cable		

There are two ways to enable Layer 3 access to Just Add Power devices:

1. The router in the system supports Static Routing. Add a Static Route to the router.
2. Change the default gateway of the control system.

## Router with Static Route

1. Confirm that the router support Static Routing. If it does not, follow [Change Default Gateway](#) instructions instead.
2. Locate the Static Route information in the [JADConfig Report](#).
3. Log into the router Static Route section. Static Route is often in Network, Routing, or Advanced sections.

**LUXUL**  
Simply Connected

Model: ABR-4400  
Firmware Version: 4.0.7

- Quick Setup
- ▶ Status
- ▼ Network
  - DHCP Server
  - Static Leases
  - Dynamic DNS
  - ▶ Multi-WAN
  - VLAN
  - Routing
- ▶ Firewall/Security
- QoS
- ▶ VPN
- ▶ Administration
- ▶ Tools

**Routes**

Active Routes

Destination IP	Subnet Mask	Gateway	Metric	Interface
default	0.0.0.0	108.191.224.1	0	WAN
10.0.0.0	255.0.0.0	192.168.1.254	3	LAN
108.191.224.0	255.255.248.0	0.0.0.0	0	WAN
172.16.0.0	255.255.0.0	192.168.1.253	10	LAN
192.168.1.0	255.255.255.0	0.0.0.0	0	LAN
192.168.2.0	255.255.255.0	192.168.1.10	2	LAN
192.168.100.0	255.255.255.0	192.168.1.50	3	LAN

Add Static Route

Description	Interface	Destination IP	Netmask	Gateway	Metric	Modify
<input type="text"/>	LAN	<input type="text"/>	<input type="text"/>	<input type="text"/>	<input type="text"/>	<input type="button" value="Add"/> <input type="button" value="Cancel"/>

Static Route page on a Luxul ABR-4400

4. Enter the Static Route information from the JADConfig Report into the router. If asked for a Metric, use 10.

Note that the following static route must be added to your router so that the control system can access the JAP devices:

Network: 192.168.200.0      Netmask: 255.255.255.0      Gateway: 192.168.1.77

Static Route information from JADConfig Report

### Add Static Route

Description	Interface	Destination IP	Netmask	Gateway	Metric	Modify
Just Add Power	LAN	192.168.200.0	255.255.255.0	192.168.1.77	10	<input type="button" value="Add"/> <input type="button" value="Cancel"/>

Adding Static Route to Luxul ABR-4400

5. Done! All devices on the network can access Just Add Power devices.

## Change Default Gateway

These steps will give a single device Layer 3 access to Just Add Power devices. Use this method if the router does not support Static Routing or to limit which devices can access Just Add Power devices.

1. Locate the Static Route information in the [JADConfig Report](#).

Note that the following static route must be added to your router so that the control system can access the JAP devices:

Network: 192.168.200.0    Netmask: 255.255.255.0    Gateway: 192.168.1.77

**Static Route information from JADConfig Report**

2. Access the IP details of the computer/control system.
3. Manually set the IP details so that the Default Gateway of the computer/control system matches the Default Gateway given in the JADConfig Report.

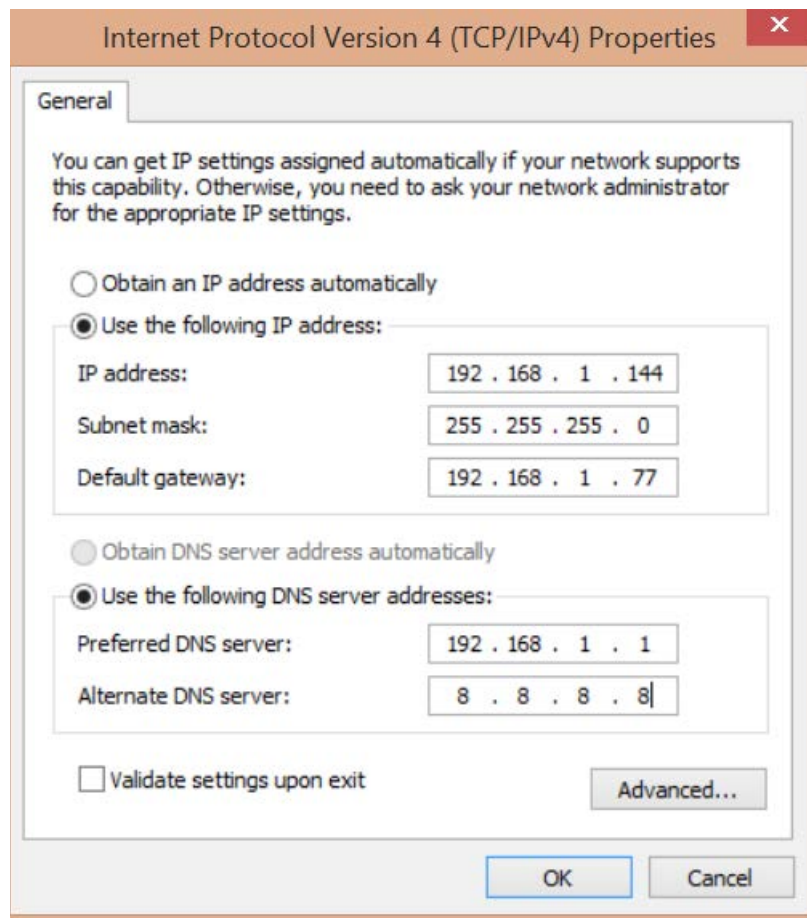

**Manually set Default Gateway**

**Note:** Devices will still have internet access as long as DNS information is entered correctly.

4. Done. The computer/control system can now access Just Add Power devices.

# Firmware Update Only

Firmware Update Only

Just update the firmware on any JAP devices visible on your LAN

Use this mode to update firmware on Just Add Power devices without configuring the switch. This mode requires that the Just Add Power devices are connected in the same network as the computer. This can mean that the computer and Just Add Power device are connected point-to-point, or that they are connected together through an **unmanaged** or **unconfigured** switch.

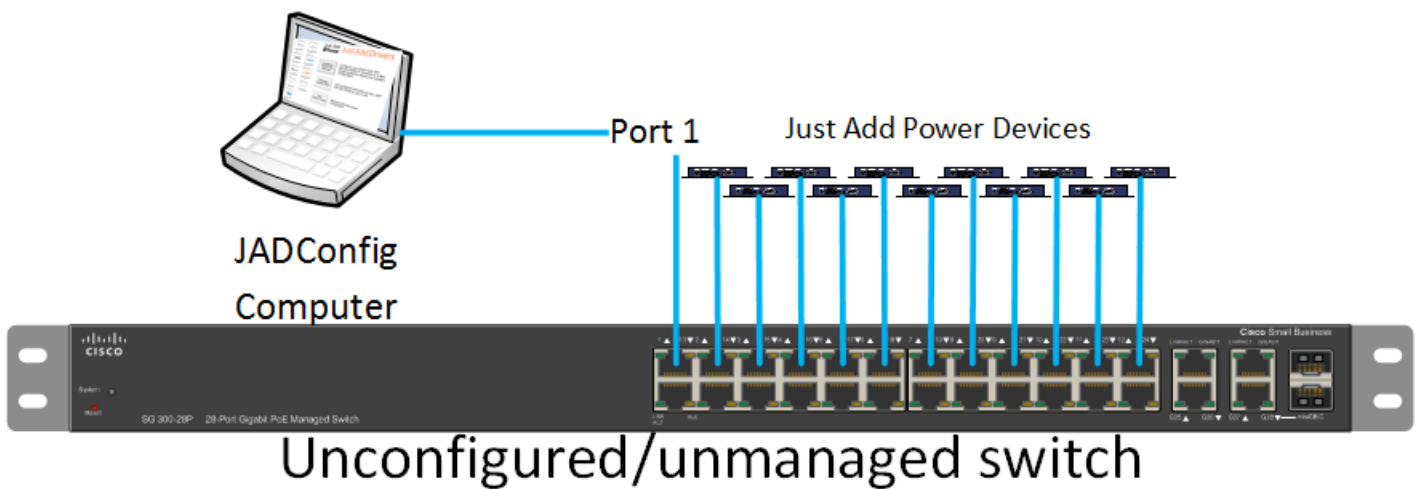

## Instructions

1. Select **Firmware Update Only** from the opening screen
2. Read the warning that appears and disconnect all HDMI cables from Transmitters. Click **OK**.

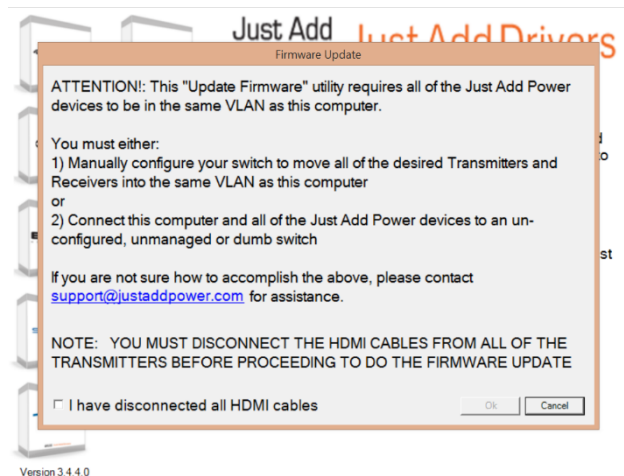

- JADConfig will discover devices that are connected to the network and show a brief summary of what it discovered. If not all devices were discovered, click **Rescan**. To move forward, click **Next>**.

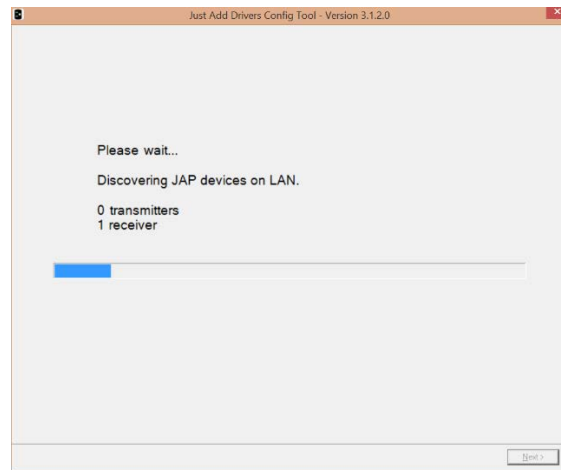

- Choose a firmware version to load onto the devices. Just Add Power recommends using the latest firmware version
  - Latest firmware for 3G is A6.4.12
  - Latest firmware for 2G is A6.4.12
- Select **Choose Image** to load an Image Push – background image – on each Receiver to show when there is no video content.
  - A *.jpg* image with *24-bit color depth* must be used
  - Any resolution image can be used, but will be displayed in 640 x 480



- Firmware will be updated on the devices and a summary will be given when finished.

## Test

Test  
(Cisco / Luxul)

Manually test the switch configuration

- Once a switch has been configured with JADConfig, **Test (Cisco/Luxul)** will act as an HDMI Matrix controller without the need for a control system.
- Test only performs input/output switching and does not provide support for Layer 3 features

### Instructions

1. Select **Test** from the opening screen
2. Wait for JADConfig to discover compatible switches on the Local Area Network, or click **Enter switch IP address manually**

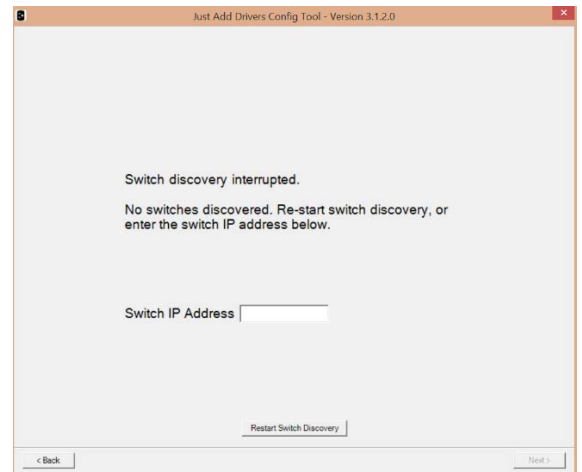
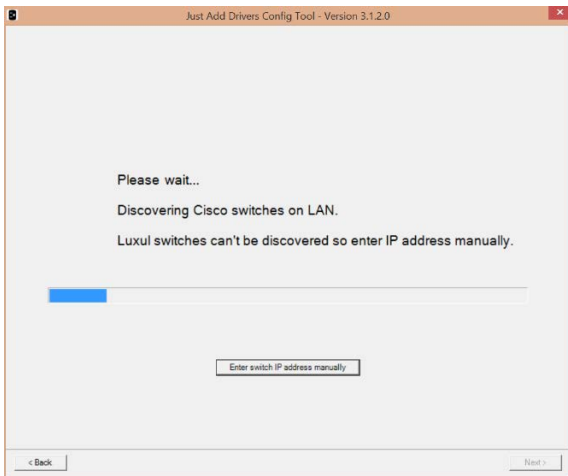

3. Select the Switch Family and enter the Username and Password

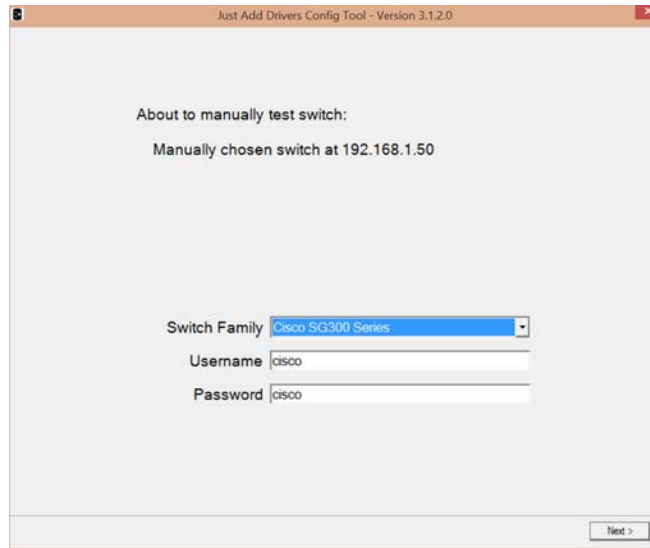

4. Use the grid image to switch inputs/outputs, and press **Next>** when finished.

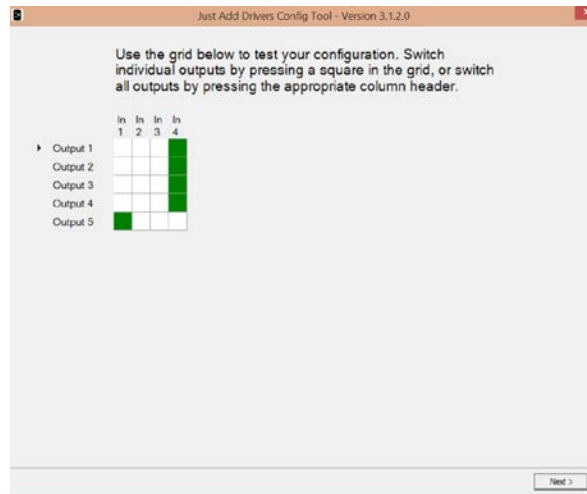

## License Key

---

### AMX

Go to the Just Add Power support site - <https://support.justaddpower.com/new> - and request a license key with the Serial Number of the AMX processor

### Control4

Go to the Just Add Power support site - <https://support.justaddpower.com/new> - and request a license key with the MAC Address of the Control4 processor

### Crestron

Go to the Just Add Power support site - <https://support.justaddpower.com/new> - and request a license key with the MAC Address or System ID (same as MAC Address) of the Crestron processor

### RTI

Go to the Just Add Power support site - <https://support.justaddpower.com/new> - and request a license key with the MAC Address of the RTI processor

### Other Control Systems

Only AMX, Control4, Crestron, and RTI drivers are programmed by Just Add Power. For other control systems, please reach out to the control system company for instructions on the driver.



# Expanding a System

A Just Add Power system can be expanded whenever needed. As long as there is an open port on the switch, there is room for additional sources and displays.

There are 2 ways to expand a system:

1. Disconnect HDMI cables from all Transmitters and run JADConfig from the beginning. Change the number of Transmitters and Receivers to fit the new system size and continue through JADConfig as normal. See [Configure Switch & Devices](#) for more info.

Configure Switch and Devices

Configure your switch and JAP devices based on answers to a few simple questions about your system configuration

2. If additional Transmitter/Receivers ports were configured for future expansion during the initial run, then the switch already has open ports for the addition of Just Add Power devices. In this case, there is no need to re-run JADConfig.

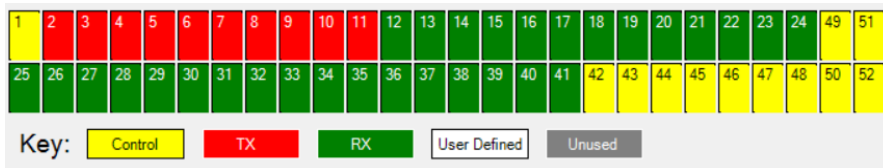

- a. Use the web interface of the new Just Add Power device(s) to manually update the firmware to match the firmware on the running system.

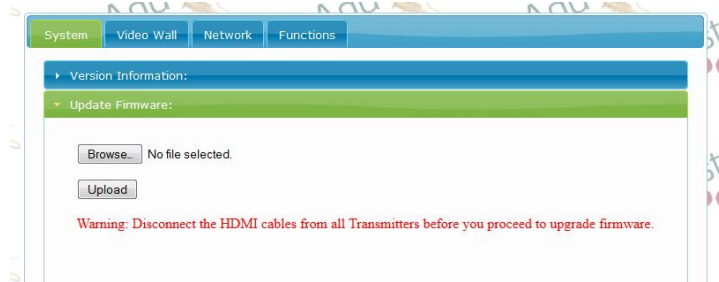

- b. Set the IP Address according to the Report file from the initial running of JADConfig



- c. Connect the unit to the correct port on the switch. Finished!

# Troubleshooting

---

## Unable to Ping Default Gateway

This message will appear if the computer is not able to communicate with the device that is assigned as its Default Gateway. If the JADConfig computer is directly connected to port 1 of the switch, this message will always appear and can be ignored.

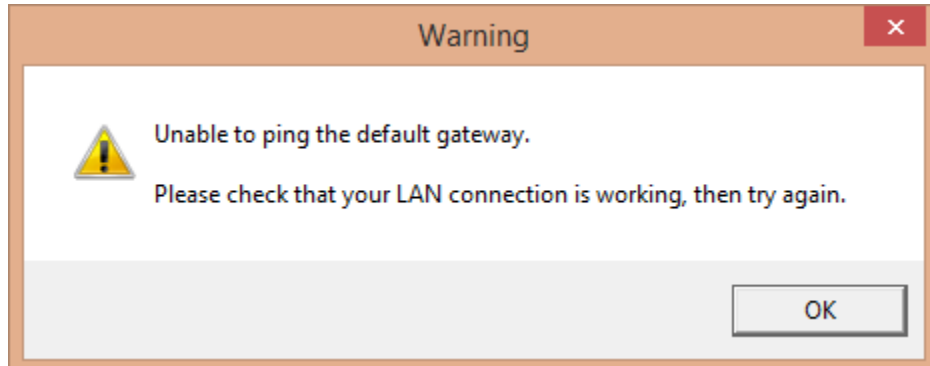

### **Solution:**

1. Click 'OK' and keep moving forward. The message does not affect JADConfig functioning at all.

## No Serial Ports were Found

This message will appear if the computer does not detect a serial port present on the computer.

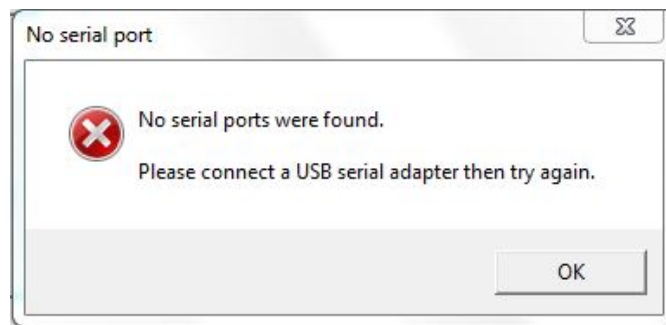

### Solution:

1. Connect a USB-to-Serial adapter to the computer and try again. If one is already connected, then it is not being recognized. Try re-connecting it or checking the driver for the adapter.
2. Try a different USB-to-Serial adapter or a different USB port on the computer.

### Stuck at “Checking communication with switch”

The “Checking communication with switch” step takes less than 10 seconds to complete. If the window remains on the screen for longer, then either the switch has recently rebooted or there is a serial communication issue between the computer and the switch.

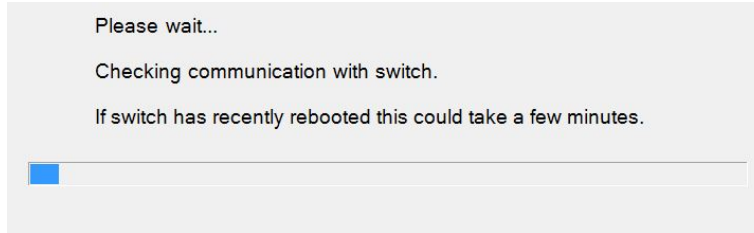

#### **Solution:**

1. Confirm that serial communication is working. Open a PuTTY session (or other terminal emulation software) at baud rate **115200-8n1** and attempt to manually communicate with the switch. If there is no communication, perform the steps below in PuTTY one-by-one until communication is established.
  - a. If possible, always use the serial cable that came with the switch. This removes any Null Modem issues.
  - b. Try adding a Null Modem to the connection. This will fix a straight-through/null modem cable issue.
  - c. Try a different serial cable or a different Serial-to-USB adapter.
  - d. Power-cycle the switch (remove power for 5 seconds, then re-apply power). This will return the switch baud rate to the default **115200-8n1** setting.
2. Reset switch to factory default settings. Switches that have been previously configured could have communication issues. If still stuck at “checking communication with switch”, retry solution 1 at factory defaults.

## Duplicate IP Address Found

This message is only a warning. It means that the IP address of the switch needs to be changed (see screen below) because there is a device already on the network that has that IP.

Please enter the following information about your system configuration.

ENSURE THE SWITCH ADDRESS SPECIFIED IS NOT ALREADY ASSIGNED TO ANOTHER DEVICE.

Transmitter Ports

Receiver Ports

Default Transmitter

Unused port mode

Switch IP Address

Default Route

Advanced

InterVLAN Routing

JAP LAN

Next >

### Solution:

- 1) Close the message box that comes up. Choose an IP address for the switch that is not already in-use on the network.

## Device Discovery Errors

In most cases, discovery will go smoothly. However, the Local Area Network topology, software, and hardware running on-site can affect the ability of JADConfig to discover Just Add Power devices in the system.

## Some Devices Discovered

There are many variables in a network that could cause JADConfig to discover some – but not all – Just Add Power devices in a system. The steps below are listed in order of the most common causes of partial discovery.

### Solutions:

1. Confirm that the most up-to-date version of JADConfig is running. The most recent version can always be found at [support.justaddpower.com](http://support.justaddpower.com) under the section *JADConfig*.
2. Confirm that all HDMI cables are **DISCONNECTED** from Just Add Power Transmitters; Transmitters sending video will flood a network with traffic and prevent discovery.

**WARNING!** More importantly, if firmware update is attempted while a Transmitter has an HDMI cable attached, there is a high probability that the Just Add Power Receivers will break and need factory recovery.

3. Confirm that all Just Add Power devices are attached to the network and powered on. A Just Add Power device that is properly connected will display a solid Power light and a blinking Data light.
4. Confirm that the network is connected to **ONLY** port 1, and that there are no other network devices attached to the switch. (Other network devices can be reconnected AFTER setup is completed).
5. Use a Windows native PC. Mac hardware running Windows may not bind the network adapters correctly, causing devices to not be discovered.
6. Disable all other network adapters present on the computer - Multiple network adapters could cause the computer to send discovery requests to the wrong network.
  - a. Go to *Network and Sharing Center* → *Change Adapter Settings*
  - b. **DISABLE** the unused network devices
  - c. This should be done for both connected and disconnected adapters
  - d. This is especially important on Windows 8 computers
7. Disable any third-party firewall or anti-virus software and allow JADConfig through the firewall (even with the firewall disabled, Windows firewall may still block discovery).
  - a. *Control Panel* → *System and Security* → *Windows Firewall*
    - i. *Turn Windows Firewall on or off*
    - ii. *Allow an app or feature through Windows Firewall*

8. Disconnect the network from port 1 of the switch and plug the computer directly into port 1 – network firewalls, security settings, etc. can interfere with discovery. Bypass the Local Area Network with the following steps:
- Write down the router's IP and the IP address and subnet mask of the computer while it is connected to the network. This can be found by opening a Command prompt (cmd.exe) and typing `ipconfig`.

```
C:\Windows\system32\cmd.exe
Microsoft Windows [Version 6.1.7601]
Copyright (c) 2009 Microsoft Corporation. All rights reserved.

C:\Users\JustAddPower>ipconfig

Ethernet adapter Local Area Connection:

    Connection-specific DNS Suffix  . : 
    IPv6 Address. . . . . : fdca:9304:4986:0:4115:6e96:dc18:8b2e
    Temporary IPv6 Address. . . . . : fdca:9304:4986:0:f1a3:ee80:0223:78fb
    Link-local IPv6 Address . . . . . : fe80::4115:6e96:dc18:8b2e%12
    IPv4 Address. . . . . : 192.168.1.5
    Subnet Mask . . . . . : 255.255.255.0
    Default Gateway . . . . . : 192.168.1.1
```

Example – Computer: 192.168.1.5, Subnet Mask: 255.255.255.0, Router: 192.168.1.1

- Disconnect the network from port 1 of the Managed switch.
- Connect the computer's wired connection to port 1 of the Managed switch (where the network was just removed.)

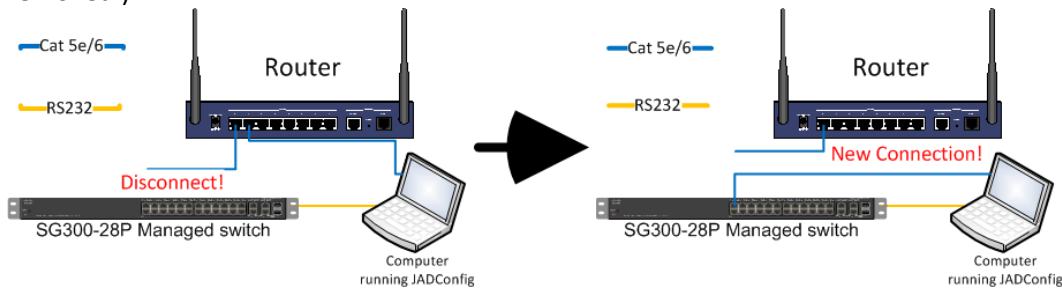

- On the computer, go to Network and Sharing Center -> Local Area Connection -> Properties -> Internet Protocol Version 4 (TCP/IPv4) -> Properties.
- Select "Use the following IP address". Input the computer's IP in the "IP address" box, computer's subnet mask in the "Subnet mask" box, and the router's IP in the "Default gateway" box. Leave DNS information blank. Select 'OK' through all network windows to confirm.

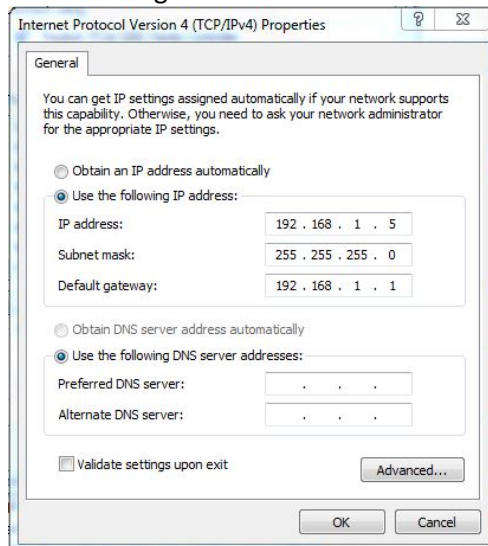

IPv4 Settings

- Re-run JADConfig from the beginning with the Local Area Network bypassed. At one point a warning message that says "Cannot ping the default gateway" will appear. Click 'OK', ignore it, and continue.
- Once JADConfig has completed, reconnect the network to port 1 of the Managed switch.

## No Devices Discovered

If no Just Add Power devices are found, it may mean that the discovery process never properly started. If this has happened, the progress bar on the discovery window will not move at all, and JADConfig will report that no devices were discovered.

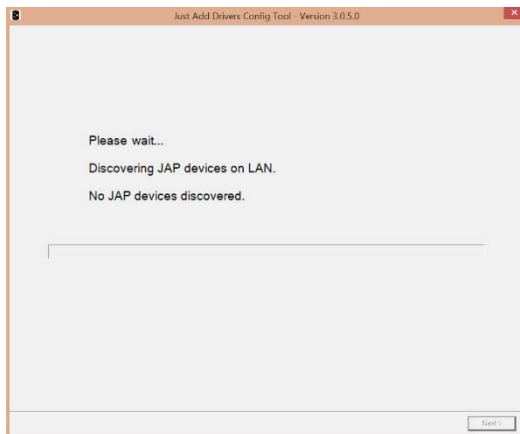

### Solutions:

- 1) Follow troubleshooting instructions in [Some Devices Discovered](#). The same issues that cause some devices to be discovered can also cause no devices to be discovered.
- 2) Disable all other network adapters present on the computer - Multiple network adapters could cause the computer to send discovery requests to the wrong network.
  - a. Go to *Network and Sharing Center* → *Change Adapter Settings*
  - b. **DISABLE** the unused network devices
  - c. This should be done for both connected and disconnected adapters
  - d. This is especially important on Windows 8 computers

- 3) There is a background program running on the computer that is preventing JADConfig from accessing the computer's discovery port – port 5353.

- a. Common programs that block port 5353
  - i. Apple AirPort Base Station Agent
    - Open AirPort Disk Preferences...
    - Uncheck the "Automatically Discover AirPort Disks" box
  - ii. Google Update
    - Close the program
  - iii. Cloud-based syncing programs
    - Close the program
  - iv. Skype
    - Close the program and background process
- b. Search for the program that is blocking port 5353
  - i. Open an Administrator Command Prompt (cmd.exe)
  - ii. Run command: `netstat -ab`
  - iii. Search the output for program(s) using port 5353 and close them.

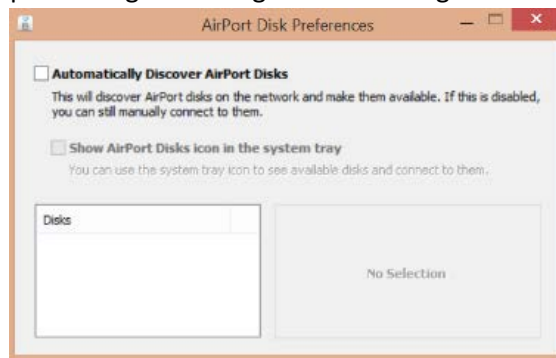

Uncheck Automatically Discover AirPort Disks

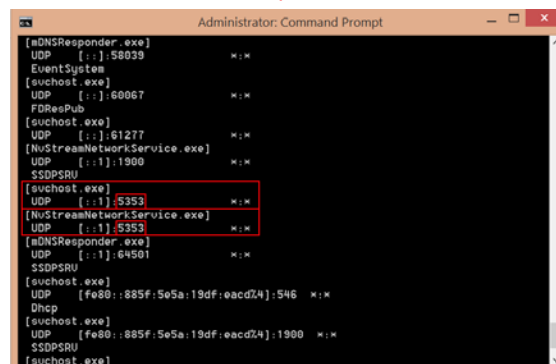

Port 5353 Programs



## Contact Support

Website

[support.justaddpower.com](http://support.justaddpower.com)

Hours

Monday – Friday

8:00 am – 5:00 pm Eastern US Time

Email

[support@justaddpower.com](mailto:support@justaddpower.com)

Phone

Main Office: +1-727-517-4053

Toll Free: +1-800-615-0206

## Change Log

---

v3.4.33.0 – April 17, 2017

- Minor bug fixes
  - 2GΩ and 2GΩ+ devices can now have a Background Image loaded
  - Corrects parsing and detection of J+P devices on Luxul switches

v3.4.30.0 – March 20, 2017

- Add support for Luxul AMS-2624P switch
- Add support for 2GΩ+ devices – 515PoE & 715PoE

V3.4.26.0 – February 10, 2017

- Update newest firmware to A6.4.12
- Add support for 2GΩ devices – 505PoE & 705PoE
- Remove firmware A6.4.1 – version no longer supported

V3.4.17.0 – October 24, 2016

- Update newest firmware to A6.4.1
- Add support for 3G standard devices and wallplate devices – 508PoE, 707PoE, 717WP2, 718WP4